

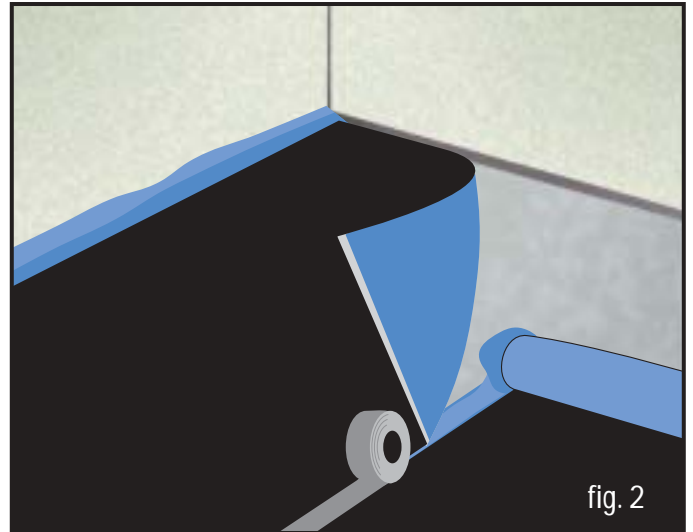

Quiet Elegance™

INSTALLATION

Please read through all instructions before starting the installation.

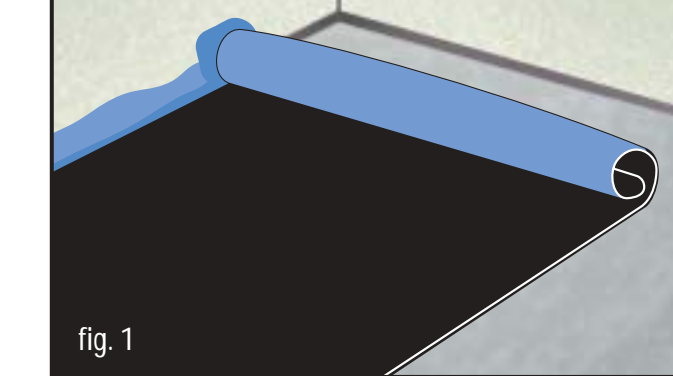
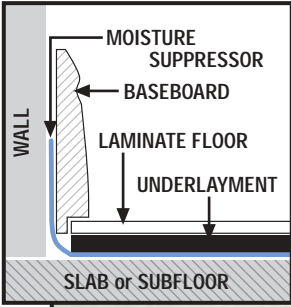

1. Install underlayment with black surface facing up on a clean, smooth, and level floor*. The blue moisture suppressor flap must run 90° to the underlayment on the starting wall (fig. 1). ***DO NOT INSTALL OVER AN EXISTING FINISHED WOOD FLOOR INSTALLED ON A CONCRETE SUBFLOOR.**

2. Continue to install the second roll of underlayment making sure to tuck the blue moisture suppressor attached flap, flat under the roll it is butted up against (fig. 2).

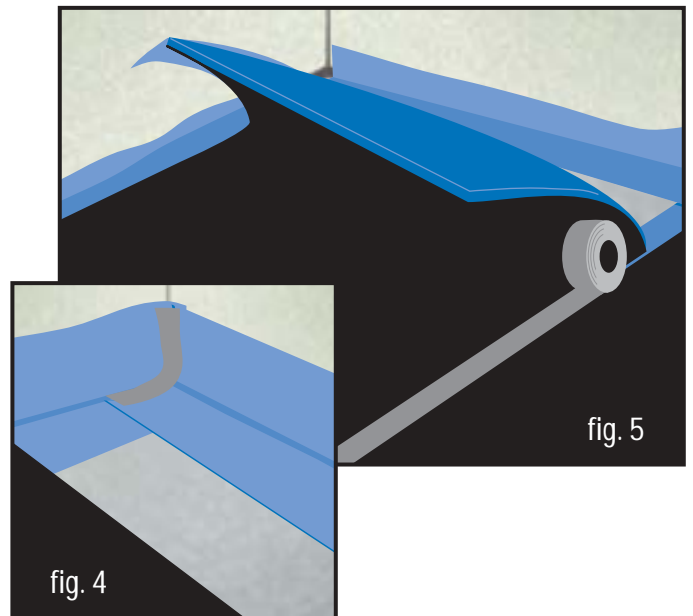
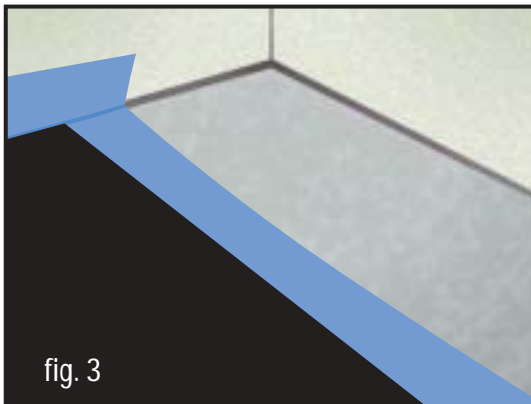

3. When using a trimmed piece of underlayment (without blue attached flap) use the included, loose blue moisture suppressor material to create a moisture barrier under each seam (fig. 3). Be sure to allow enough blue moisture suppressor material to go up the wall before installing moulding. Butt all seam edges together, making sure you have installed the blue moisture suppressor below, and seal with duct tape (fig. 6).

Also, use the blue material to create moisture barriers at all ending walls and corners (fig. 4 & 5). Once all seam edges are together, seal underlayment with duct tape (fig. 6).

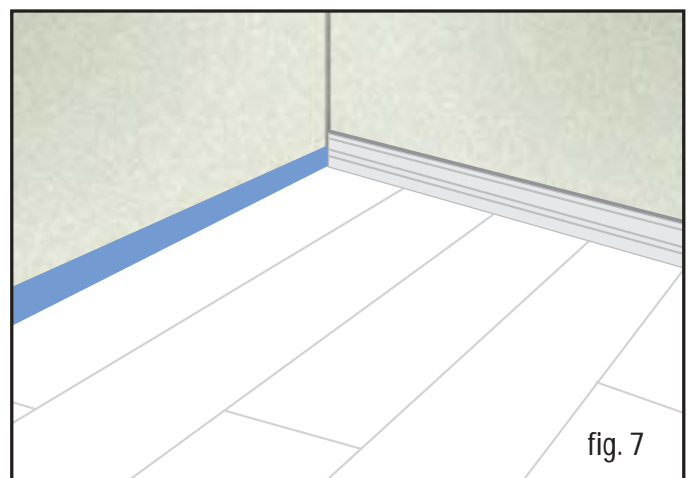
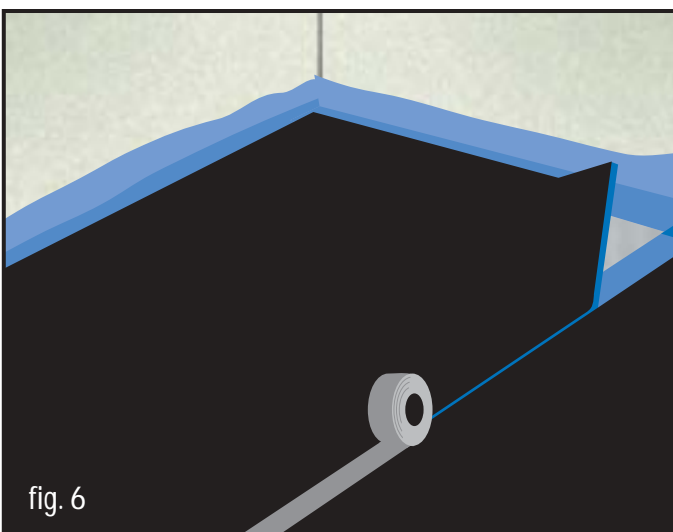

Trim the blue film to half the height of the moulding, then install finishing moulding (fig. 7).



Quiet Elegance™

INSTALACIÓN

Por favor lea todas las instrucciones antes de iniciar la instalación.

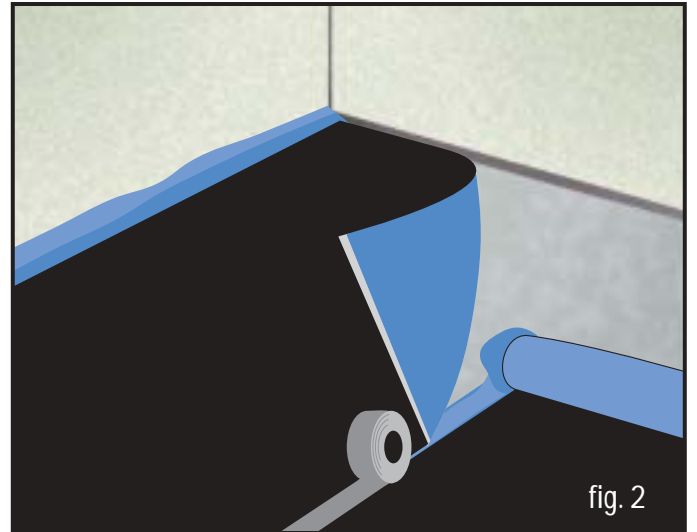
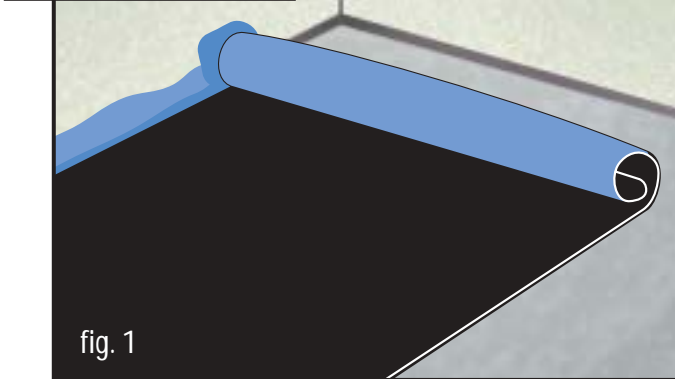
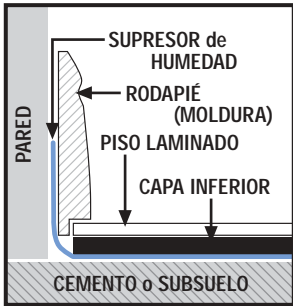

1. Instale la capa inferior con la superficie negra hacia arriba en un piso limpio, liso y nivelado *. La solapa supresora de humedad azul deberá estar a un ángulo de 90° a la capa inferior en la pared inicial (fig. 1).

***NO INSTALAR SOBRE UN PISO EXISTENTE DE MADERA QUE HAYA SIDO INSTALADO SOBRE UN SUBSUELO DE CEMENTO.**

2. Continúe instalando el segundo rollo de capa inferior asegurándose de meter la solapa supresora de humedad azul debajo del rollo que se colocó anteriormente (fig. 2).

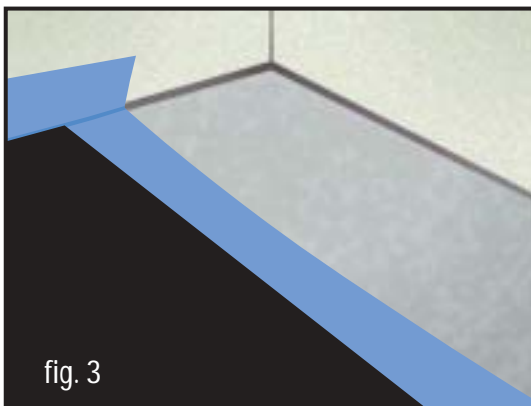

3. Al usar un pedazo recortado de capa inferior (sin la solapa azul), use el material suelto supresor de humedad incluido, para crear una barrera contra la humedad debajo de cada comisura (fig. 3). Asegúrese de permitir que suficiente material azul, supresor de humedad suba la pared antes de instalar la moldura. Una todas las orillas, asegúrese de instalar el supresor azul de humedad debajo de cada comisura, y selle con cinta para ductos (fig. 6).

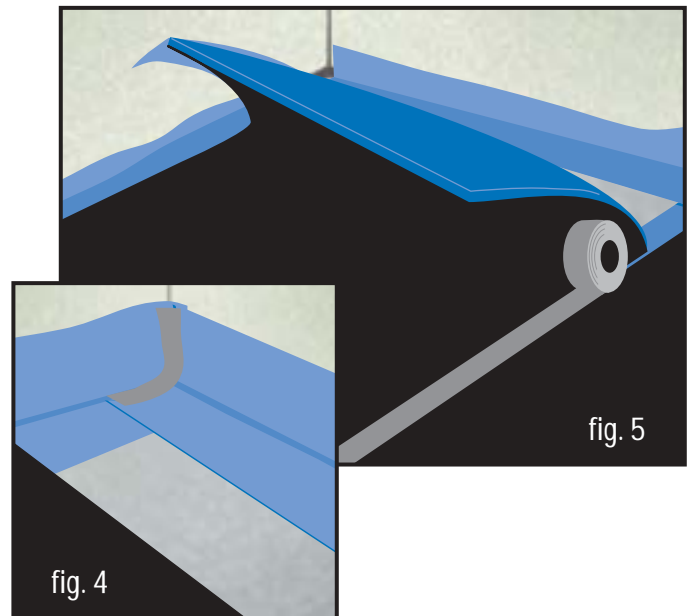

Adicionalmente, use el material azul para crear barreras contra la humedad en todas las paredes y esquinas afectadas (fig. 4 & 5). Una vez que todos los bordes estén unidos, selle la capa inferior con cinta para ductos (fig. 6).

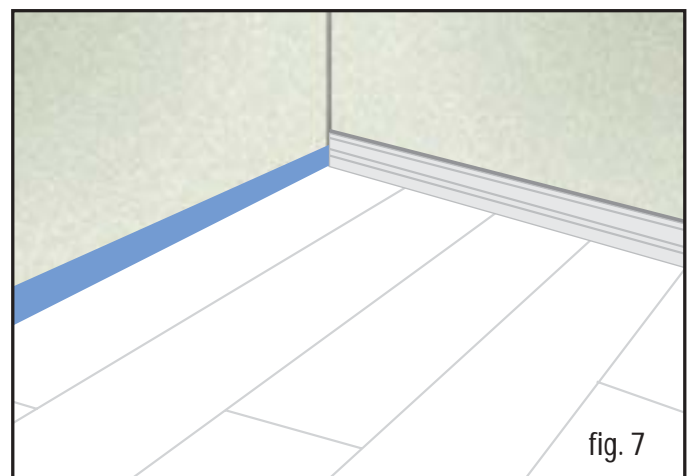
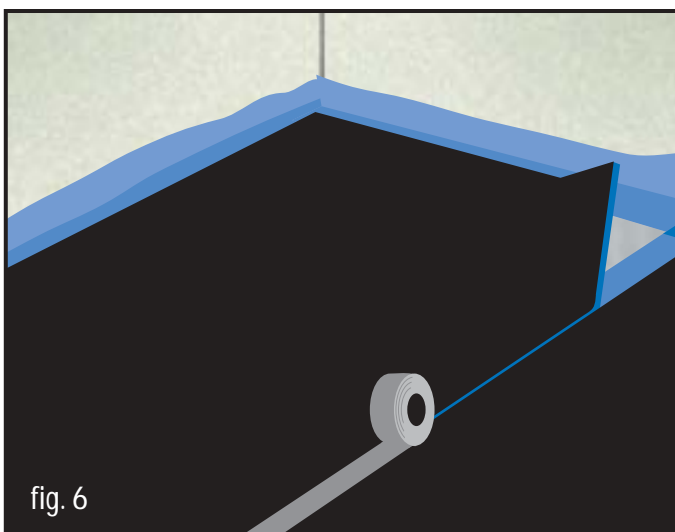

Recorte el material azul a la mitad de la altura de la moldura, entonces termine de instalar la moldura (fig. 7).